

**Notes:**

1. All treads and landing treads are Original Select Flat Sawn Old Heart Antique River Pine.
2. The material will have some knots
3. Grain will run in same line as tread bullnose.
4. All winders will be made from templates verified in field. (Treads are NOT to be made from dimensions shown. Dimensions are approximate and only for ordering material.)
5. All straight treads will be measured and verified in the field.

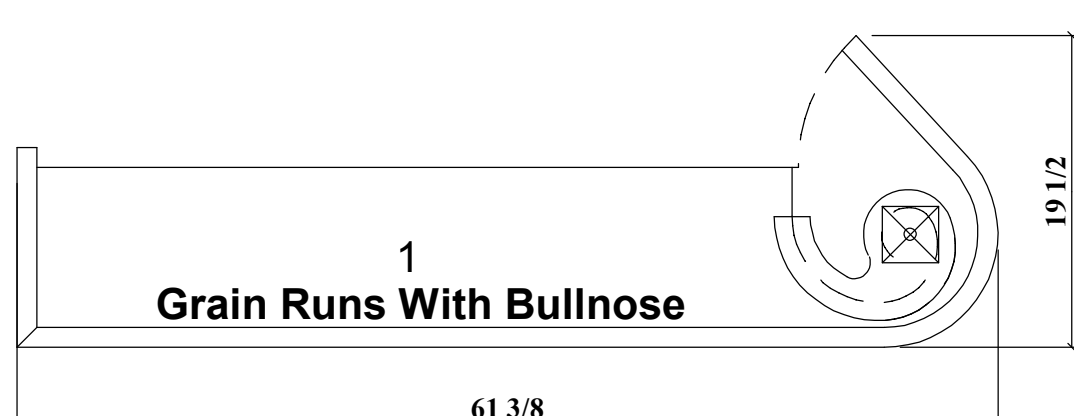
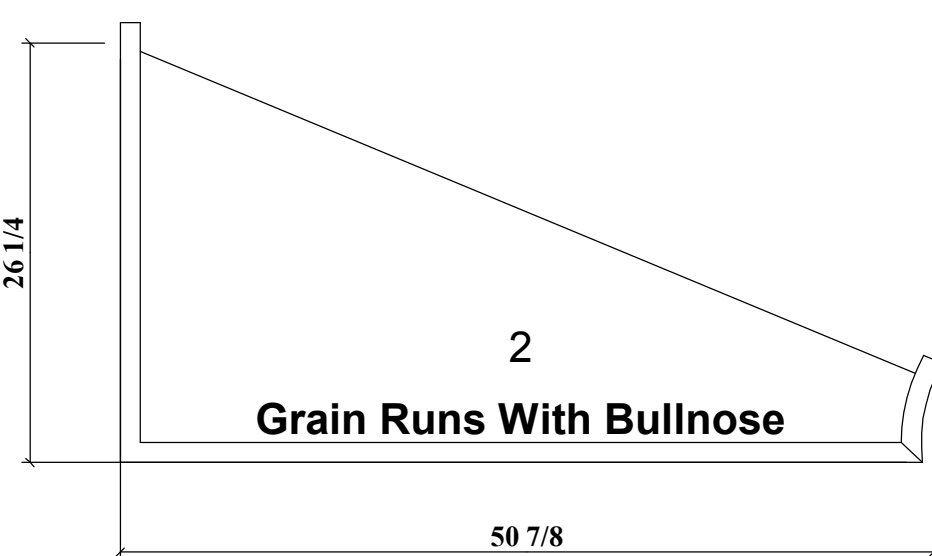
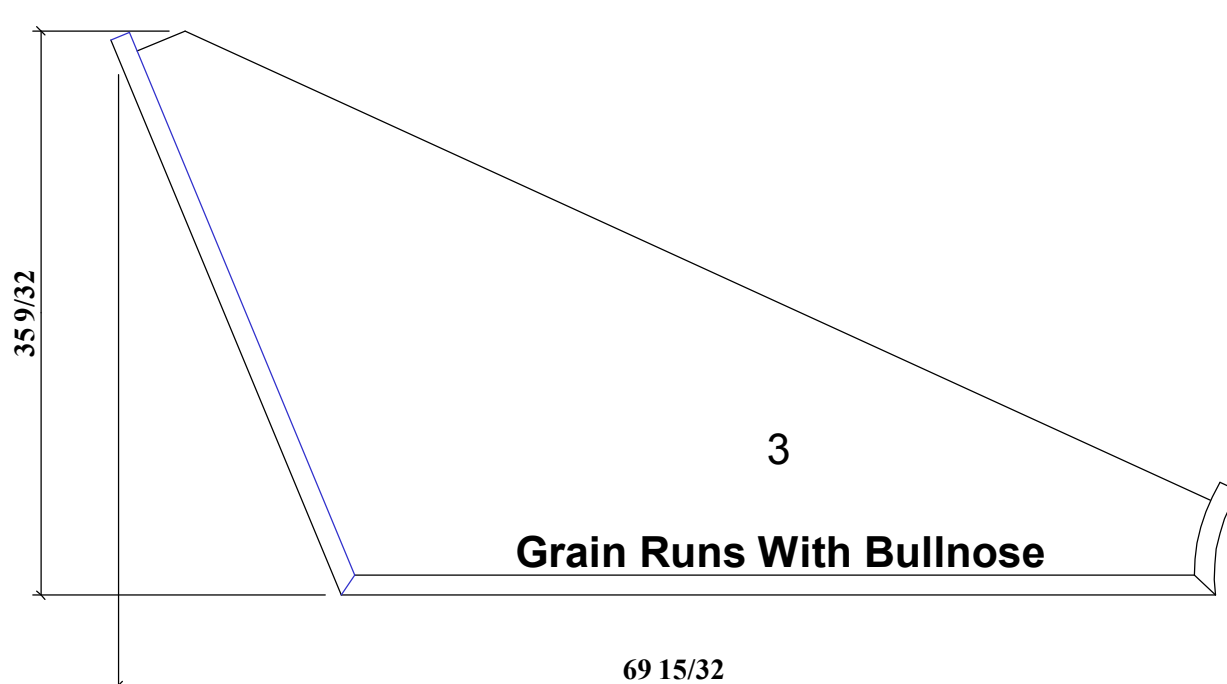
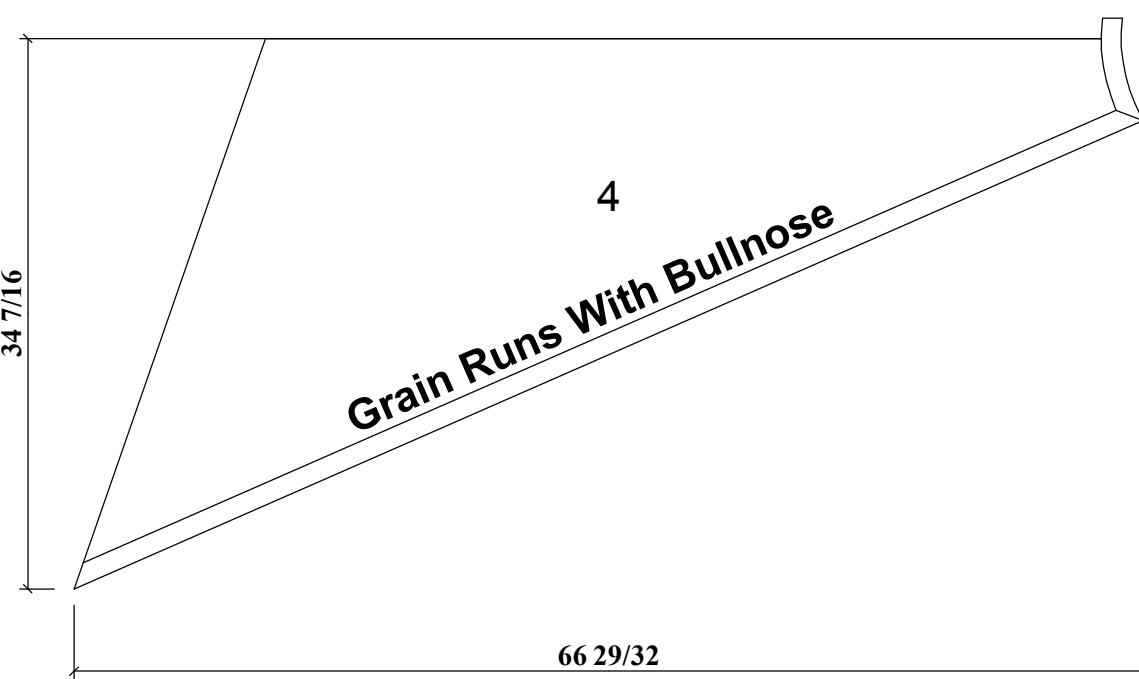
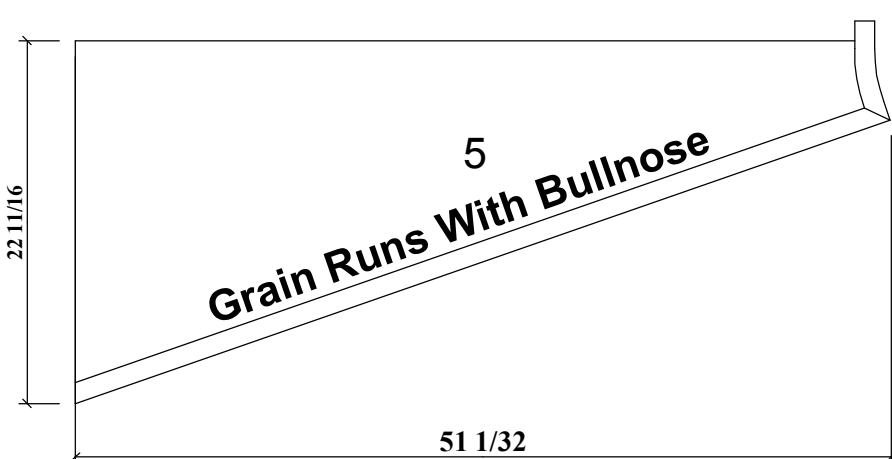
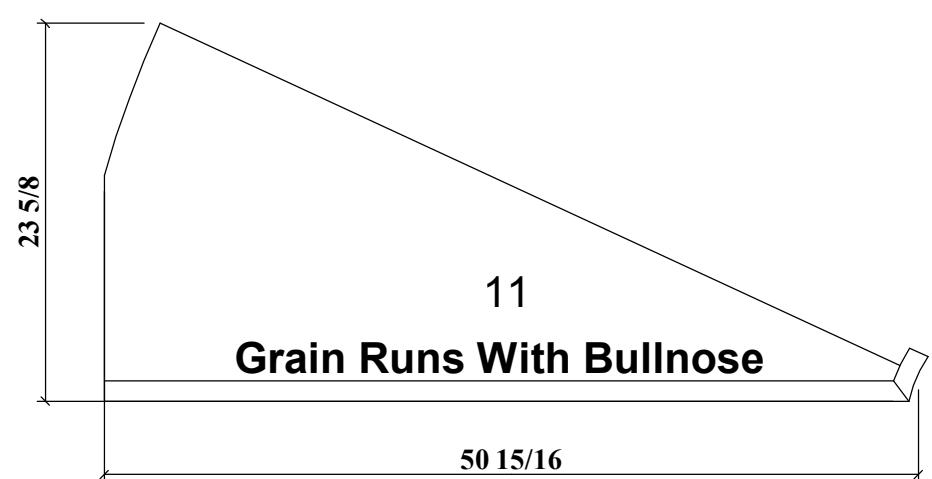
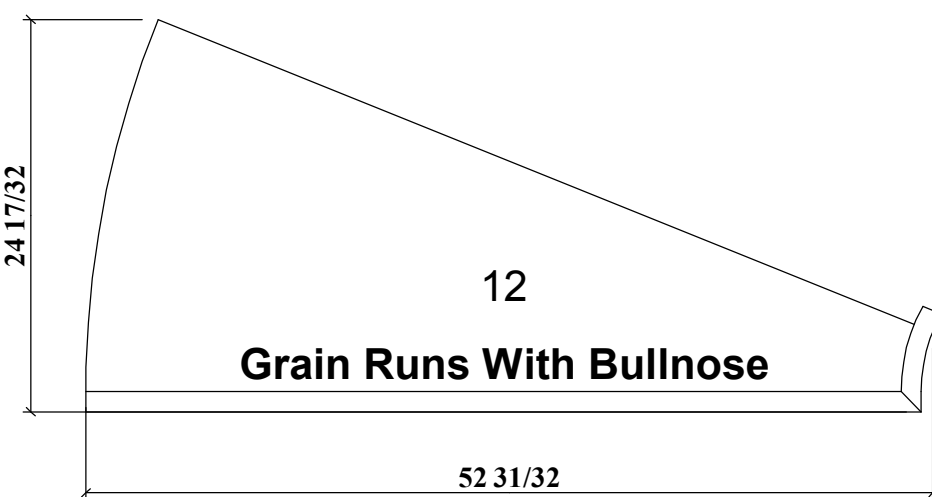
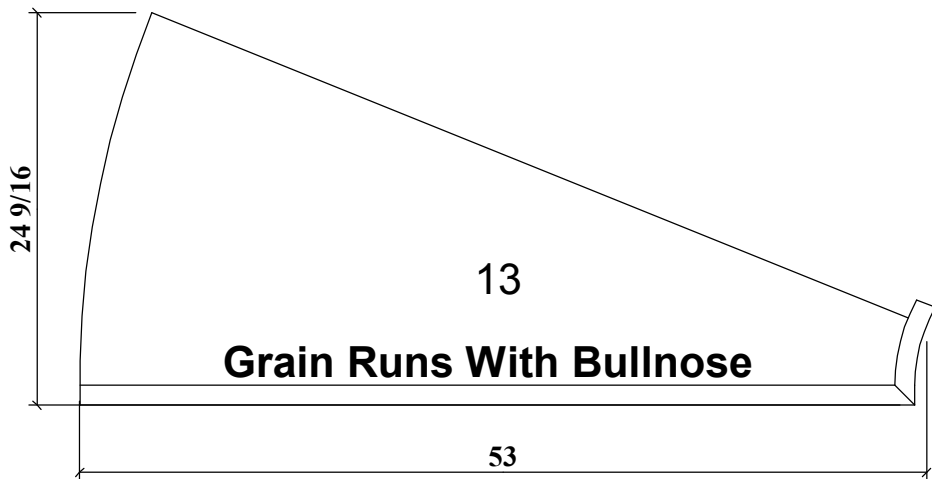
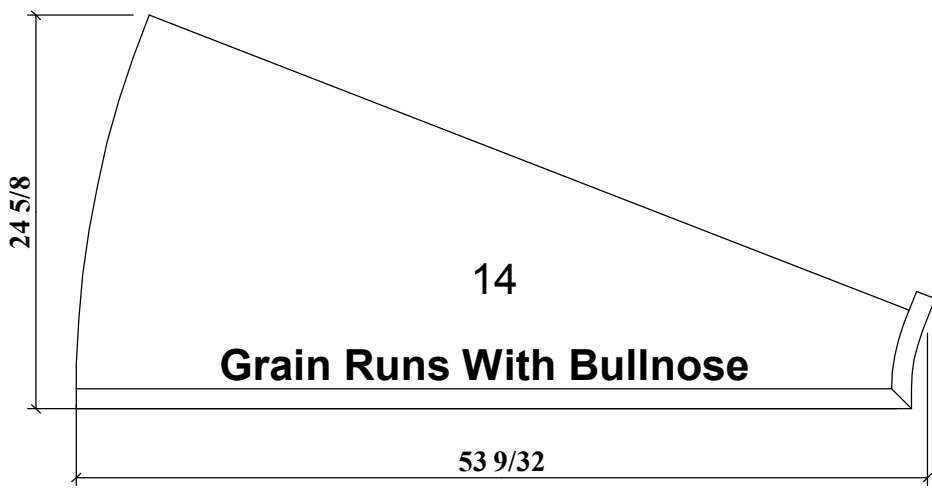

**Notes:**

1. All treads and landing treads are Original Select Flat Sawn Old Heart Antique River Pine.
2. The material will have some knots
3. Grain will run in same line as tread bullnose.
4. All winders will be made from templates verified in field. (Treads are NOT to be made from dimensions shown. Dimensions are approximate and only for ordering material.)
5. All straight treads will be measured and verified in the field.

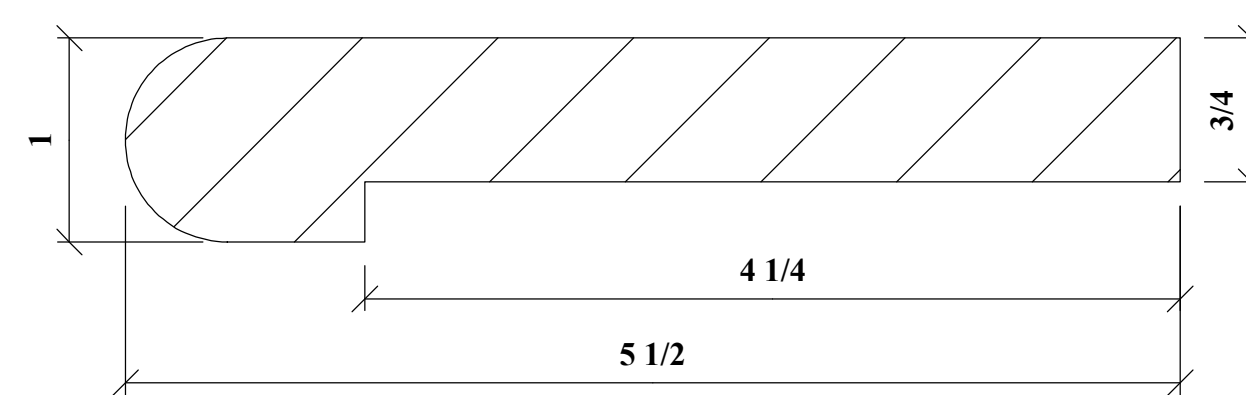
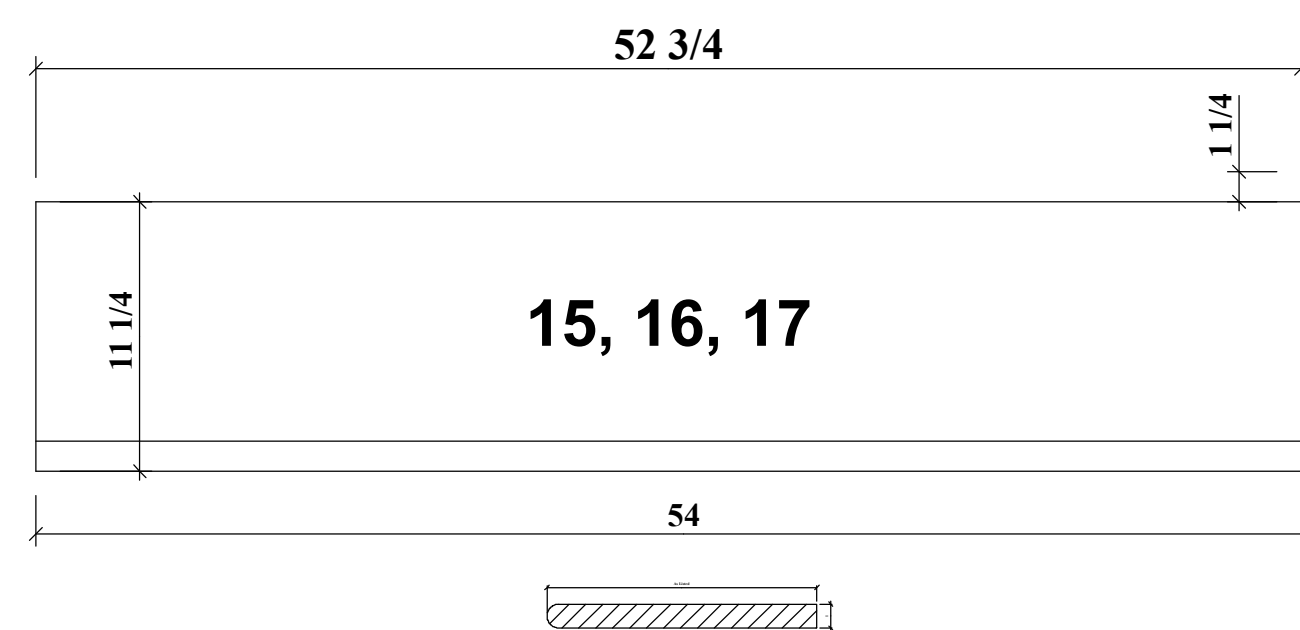
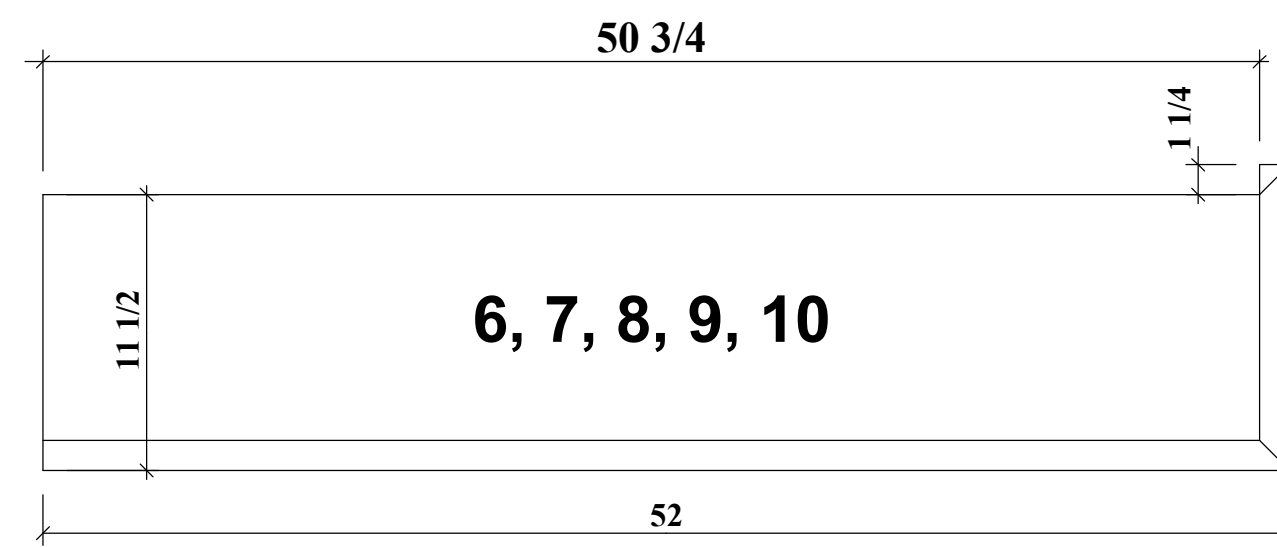

**Pine Landing Tread (Match Treads)**

80 lf - 1 x 5 1/2

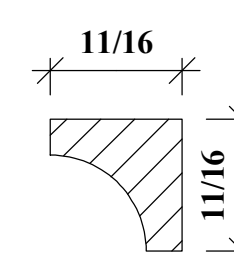

**Poplar Cove**

160 lf - 11/16 x 11/16  
 Plus Radius As Required

**Riser & Skirt Material**

- 80 lf - 3/4 x 12 - S4S Poplar - Skirt
- 16 pcs - 1/4 x 12 - S4S MDF - Skirt  
 (For Bending Into Curved Areas)
- 85 lf - 3/4 x 7 1/2 - S4S Poplar - Riser

Qty	Description	Notes
5 ea	#4815 Regency Newels - 56" - Mahogany	Pin Top
62 lf	#6010 Rail - 2 1/4 x 1 3/8 - Mahogany	4 ea - 10/0, 2 ea - 8/0, 1 ea - 6/0
2 ea	#6010 Curved Rail Sections - Mahogany	From Job Site Patterns
5 ea	#7014 Up Easings, 90 Degree - Mahogany	6" Radius
1 ea	#7012 Up Easing, 60 Degree - Mahogany	9 1/8" Radius
3 ea	#7013 Over Easings, 60 Degree - Mahogany	9 1/8" Radius
1 ea	#7035 Volute - Right Hand - Mahogany	
1 ea	#7019 Opening Cap - Mahogany	Newel Cap
5 ea	#7020 Tandem Caps - Mahogany	Newel Caps
6 ea	#7117 Rosettes, 4 1/2" Round - Mahogany	
1 ea	#5215 Tiffany Baluster, 1 1/4" x 31" - Poplar	All Balusters Taper To 3/4"
130 ea	#5215 Tiffany Baluster, 1 1/4" x 35" - Poplar	Includes 5 Extra
12 ea	#5215 Tiffany Baluster, 1 1/4" x 37" - Poplar	Includes 1 Extra
7 ea	#5215 Tiffany Baluster, 1 1/4" x 39" - Poplar	Includes 1 Extra
17 ea	#5215 Tiffany Baluster, 1 1/4" x 41" - Poplar	Includes 2 Extra
4 ea	#5215 Tiffany Baluster, 1 1/4" x 43" - Poplar	Includes 1 Extra
30 ea	#3001 Rail Bolts	
15 ea	#3000 Rail Plugs	

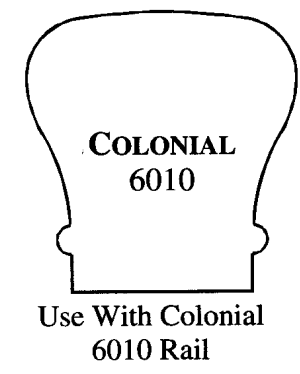
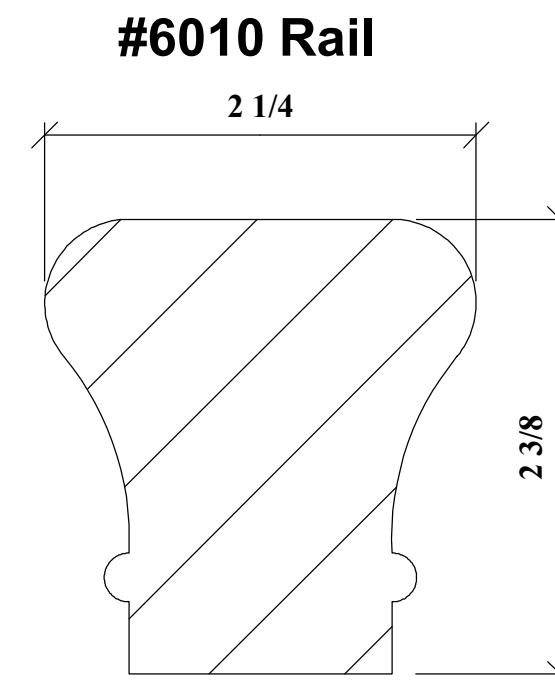

Use With Colonial 6010 Rail

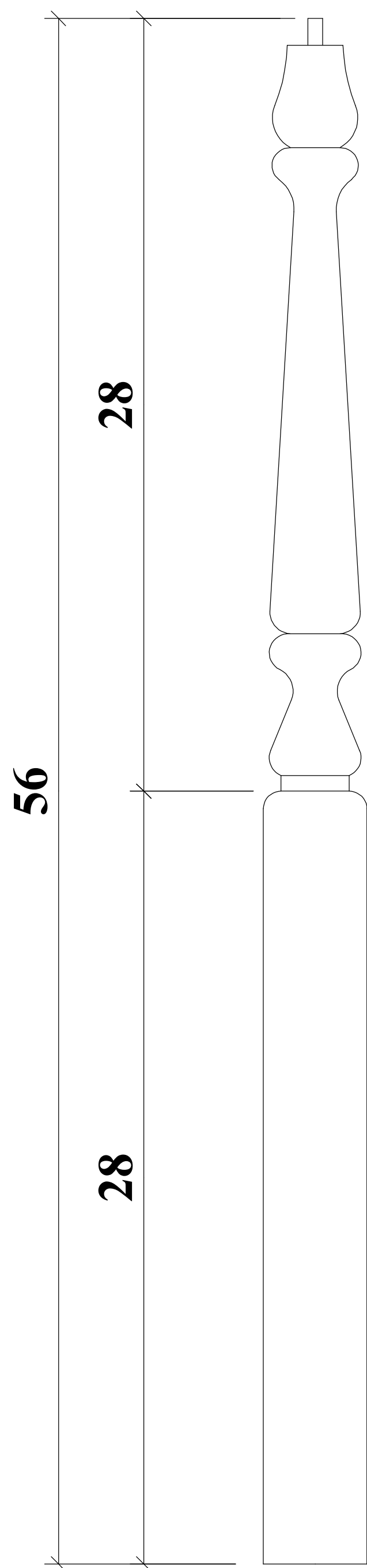
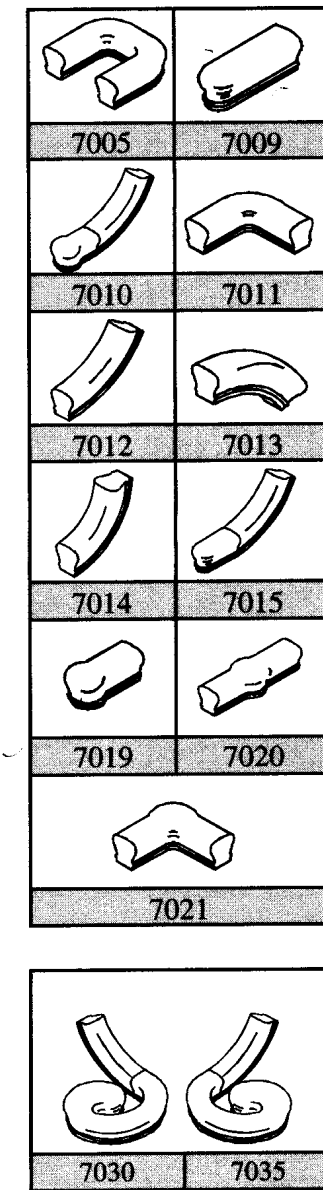

#4815 - Regency Newel Pin Top

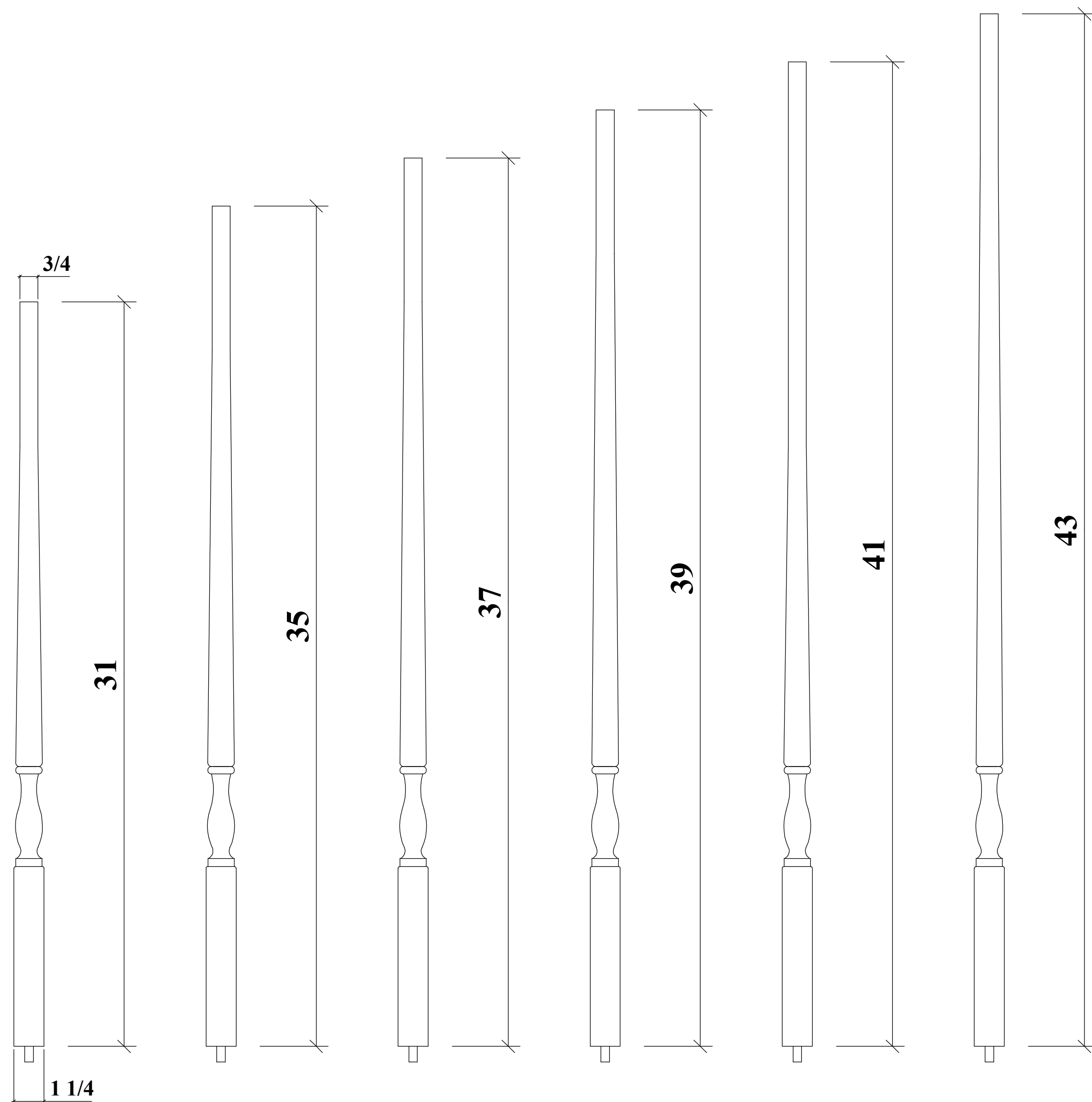

#5215 Tiffany Balusters