

Section 3: Casing, Backband & Plinth Mouldings

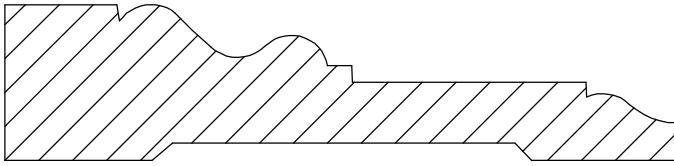

Casing 1-1
13/16" x 3 1/2"

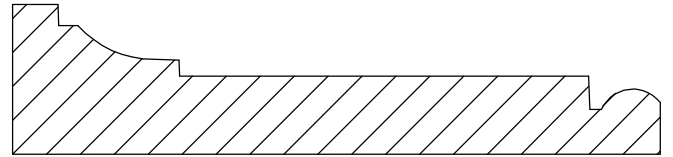

Casing 1-2
13/16 x 3 3/8

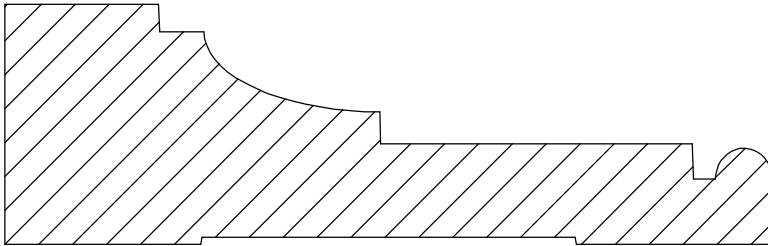

Casing 1-3
1 1/4" x 4"

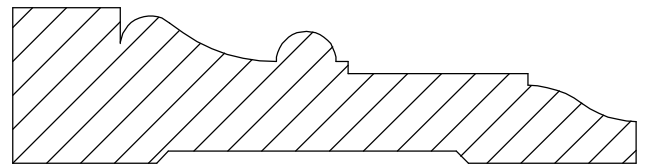

Casing 1-4
13/16" x 3 1/4"

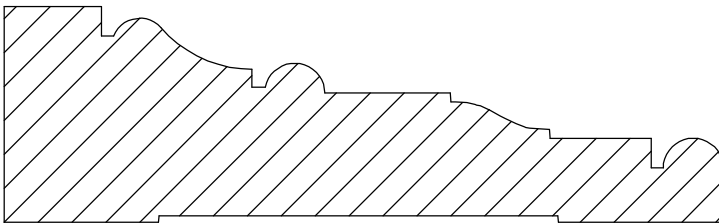

Casing 1-5
1 1/8" x 3 3/4"

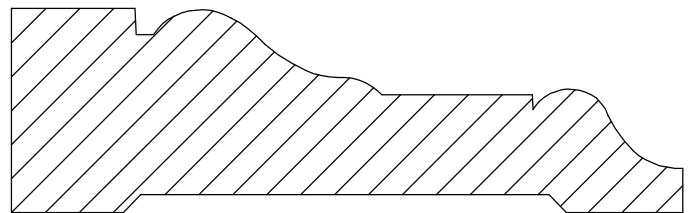

Casing 1-6
1 1/16" x 3 1/2"

Section 3: Casing, Backband & Plinth Mouldings

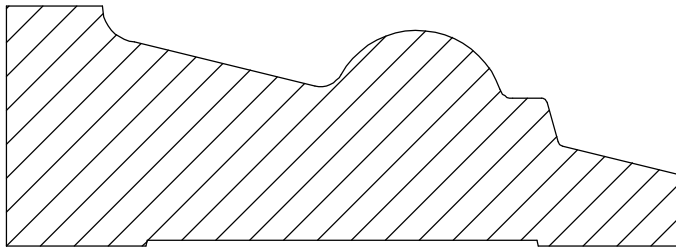

Casing 2-1
1 1/4" x 3 1/2"

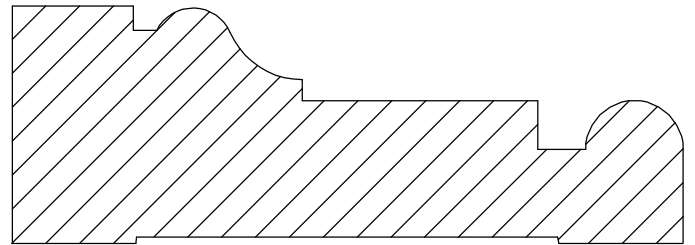

Casing 2-2
1 1/4" x 3 1/2"

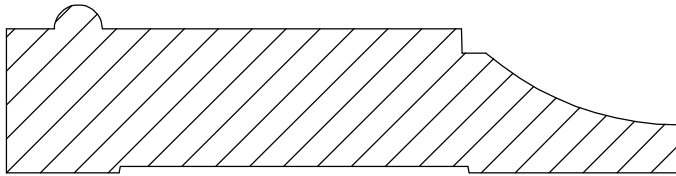

Casing 2-3
7/8" x 3 1/2"

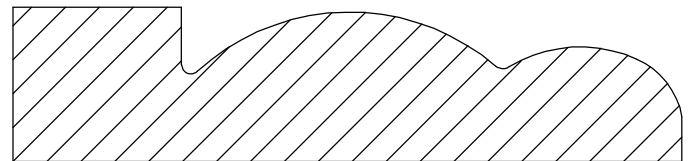

Casing 2-4
13/16" x 3 1/2"

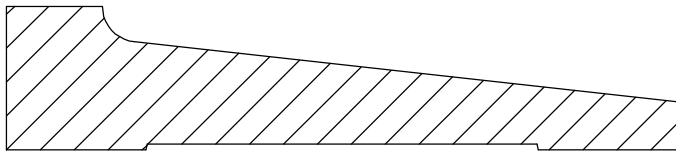

Casing 2-5
3/4" x 3 1/2"

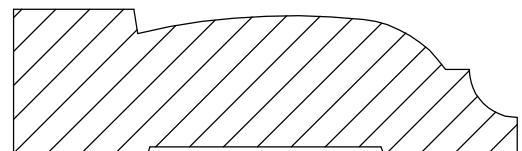

Casing 2-6
3/4" x 2 3/8"

Section 3: Casing, Backband & Plinth Mouldings

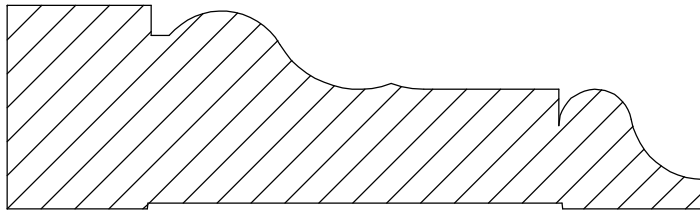

Casing 3-1
1 1/16" x 3 5/8"

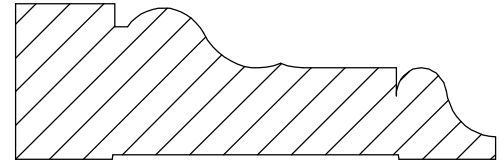

Casing 3-2
13/16" x 2 1/2"

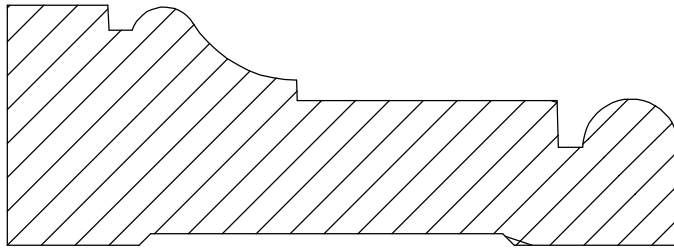

Casing 3-3
1 1/4" x 3 1/2"

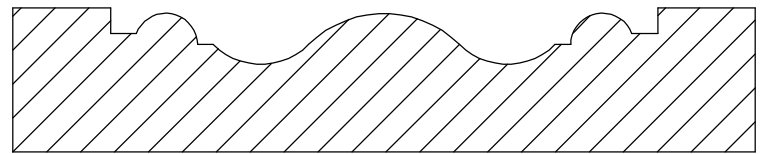

Casing 3-4
3/4" x 3 7/8"

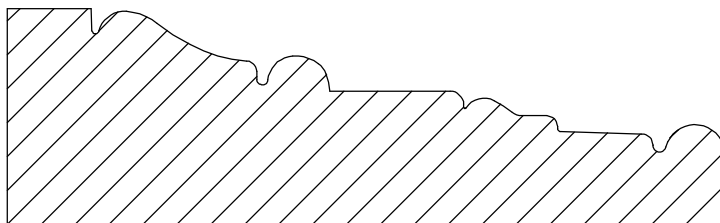

Casing 3-5
1 1/8" x 3 5/8"

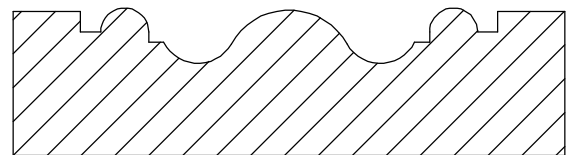

Casing 3-6
13/16" x 2 7/8"

Section 3: Casing, Backband & Plinth Mouldings

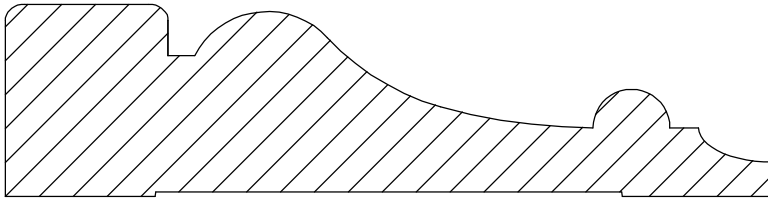

Casing 4-1
1" x 4"

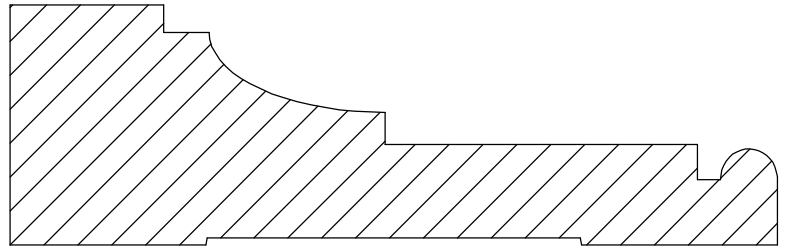

Casing 4-2
1 1/4" x 4"

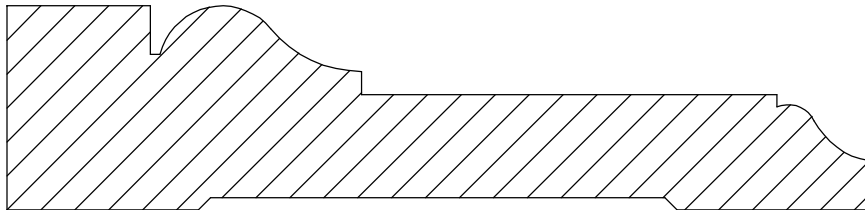

Casing 4-3
1 1/16" x 4 1/2"

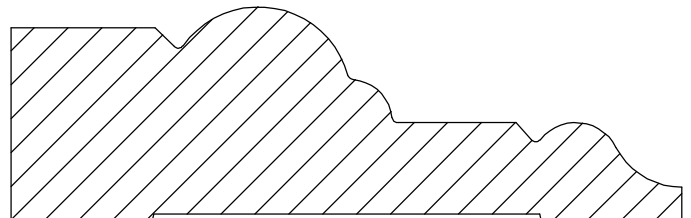

Casing 4-4
1 1/8" x 3 1/2"

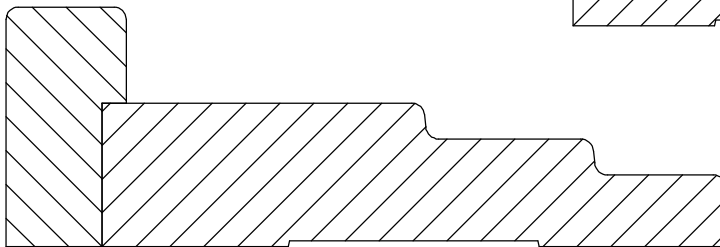

Casing 4-5
1 1/4" x 3 3/4"

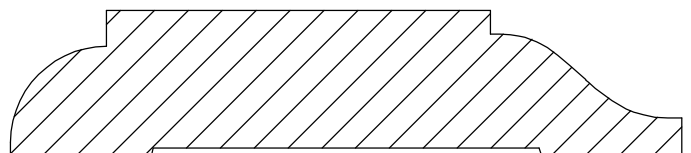

Casing 4-6
3/4" x 3 1/2"

Section 3: Casing, Backband & Plinth Mouldings

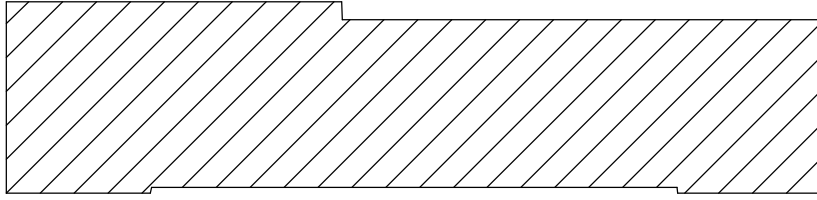

Casing 5-1
1" x 4 1/4"

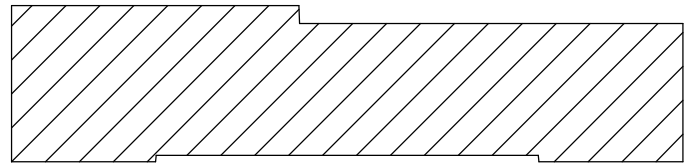

Casing 5-2
13/16" x 3 1/2"

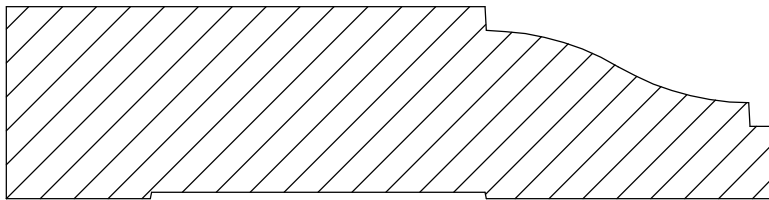

Casing 5-3
1" x 4"

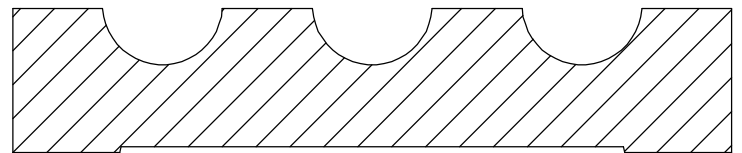

Casing 5-5
3/4" x 3 3/4"

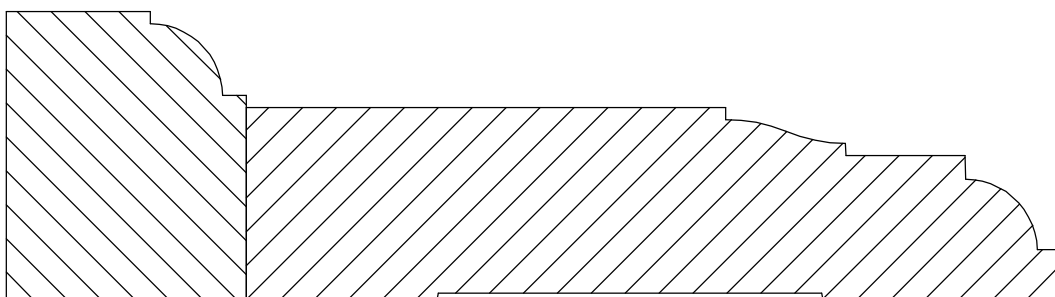

Casing 5-6
1 1/2" x 5 1/2"

Section 3: Casing, Backband & Plinth Mouldings

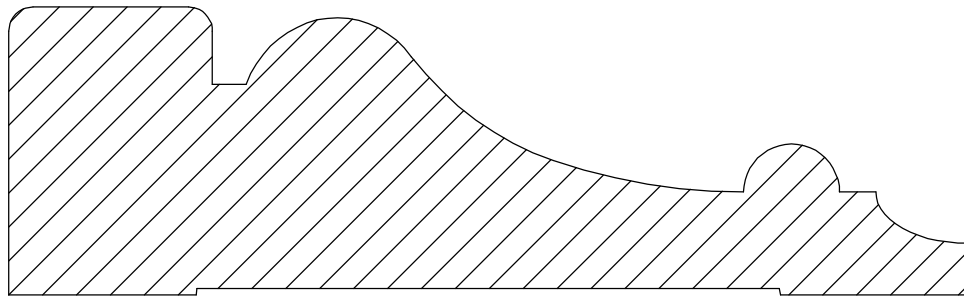

Casing 6-1
1 1/2" x 5"

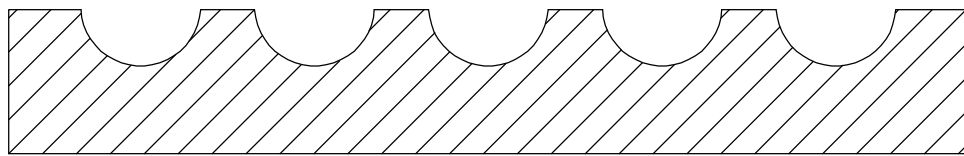

Casing 6-2
3/4" x 5"

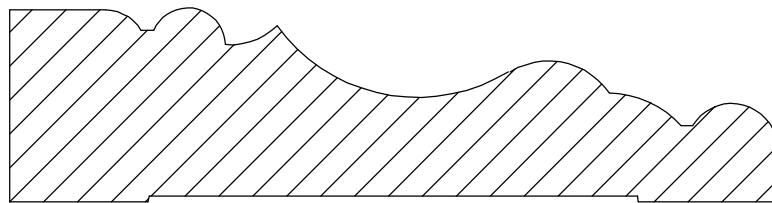

Casing 6-3
1" x 4"

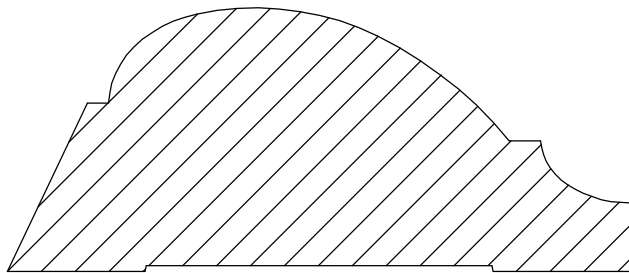

Casing 6-4
1 3/8" x 3 1/4"

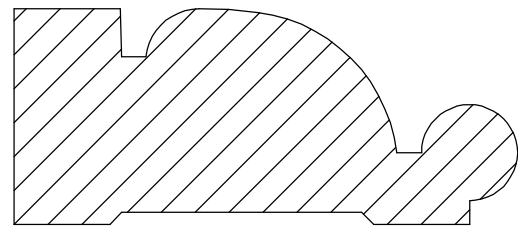

Casing 6-5
1 1/8" x 2 5/8"

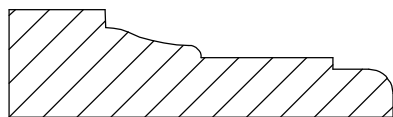

Casing 6-6
9/16" x 2"

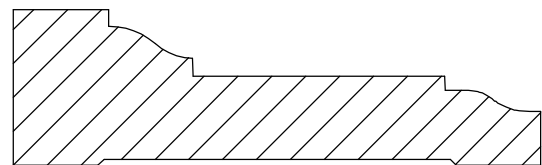

Casing 6-7
13/16" x 2 3/4"

Section 3: Casing, Backband & Plinth Mouldings

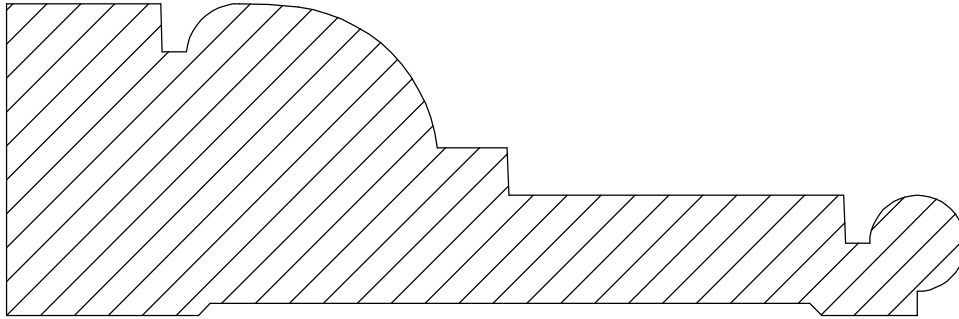

Casing 7-1
1 5/8" x 5"

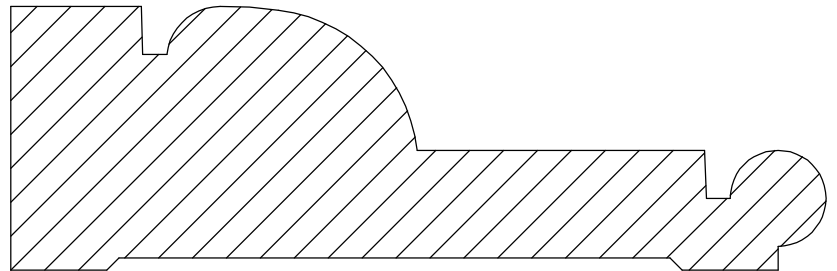

Casing 7-2
1 3/8" x 4 1/4"

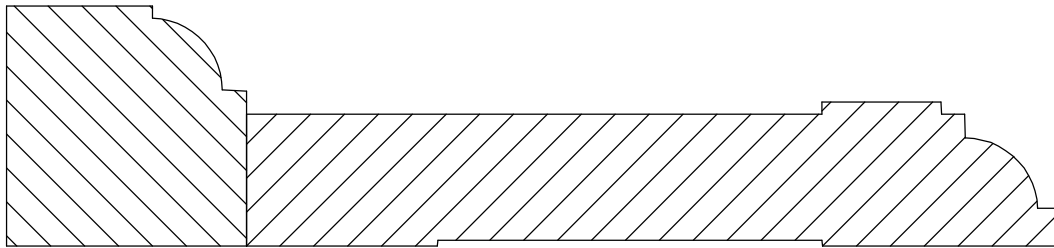

Casing 7-3
1 1/4" x 5 1/2"
2-Member

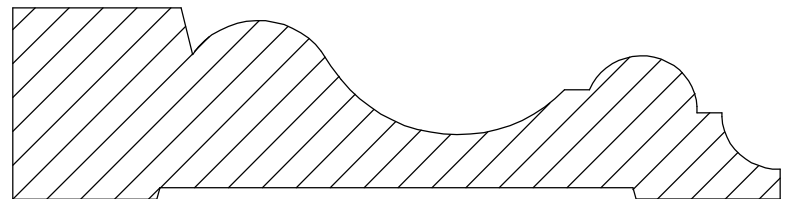

Casing 7-4
1" x 4"

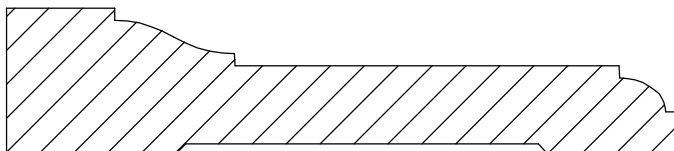

Casing 7-5
3/4" x 3 1/2"

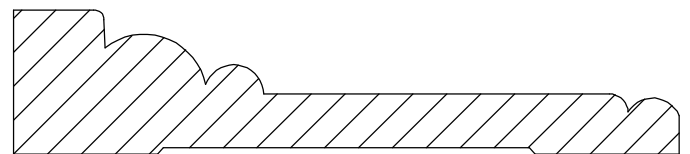

Casing 7-6
3/4" x 3 1/2"

Section 3: Casing, Backband & Plinth Mouldings

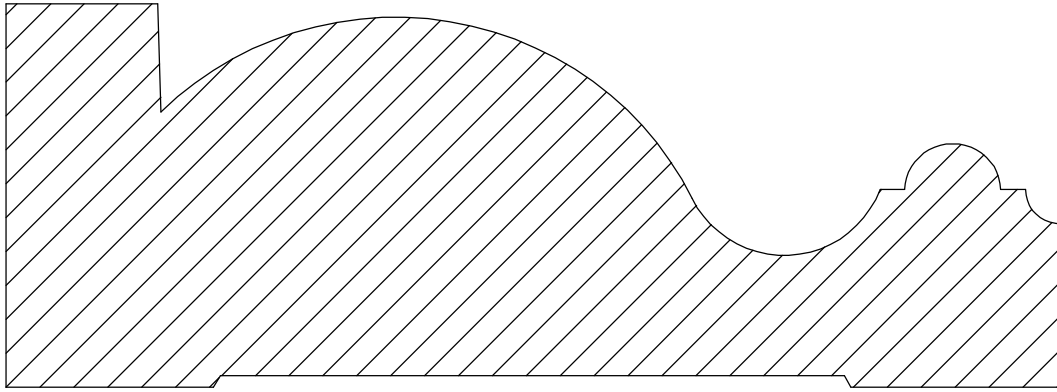

Casing 8-1
2" x 5 1/2"

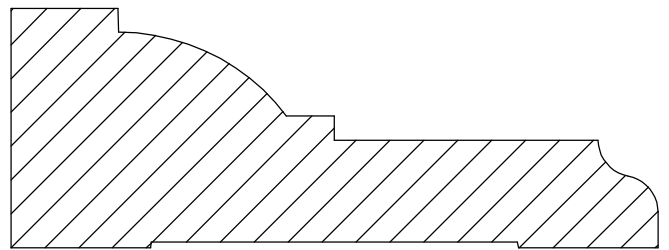

Casing 8-2
1 1/4" x 3 3/8"

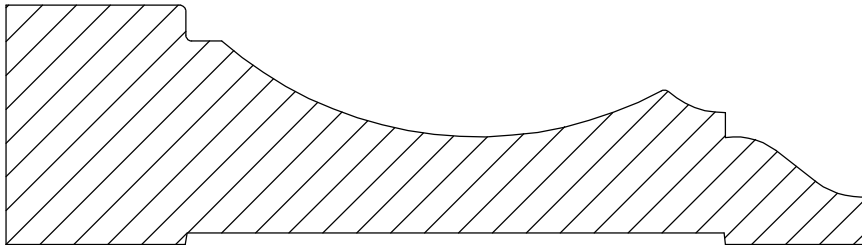

Casing 8-3
1 1/4" x 4 1/2"

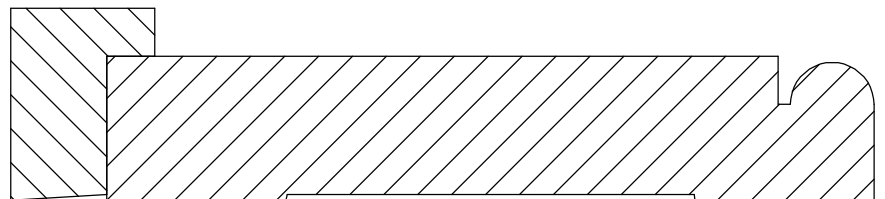

Casing 8-4
1" x 4 1/2"

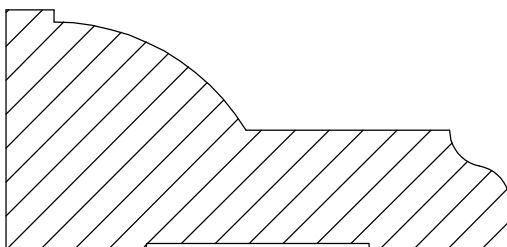

Casing 8-5
1 1/4" x 2 5/8"

Section 3: Casing, Backband & Plinth Mouldings

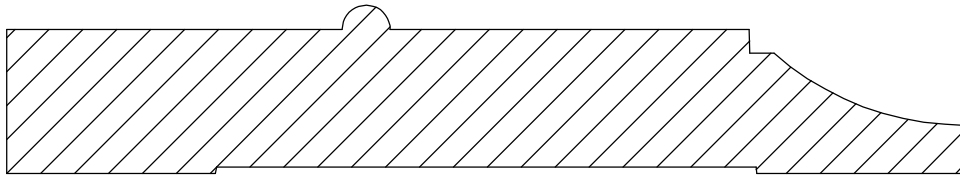

Casing 9-1
7/8" x 5"

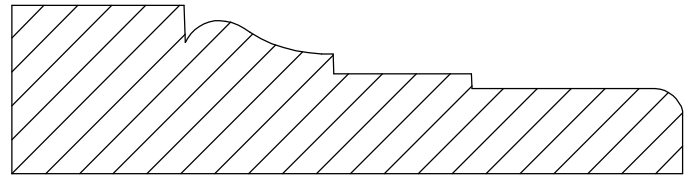

Casing 9-2
7/8" x 3 1/2"

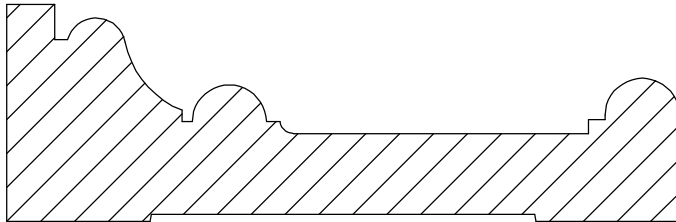

Casing 9-3
1 1/8" x 3 1/2"

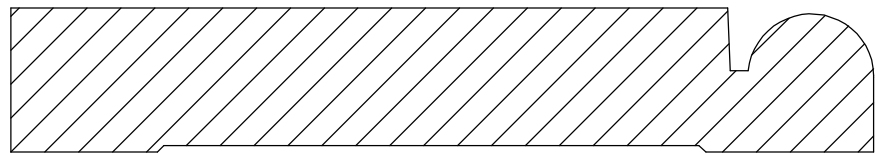

Casing 9-4
3/4" x 4 1/2"

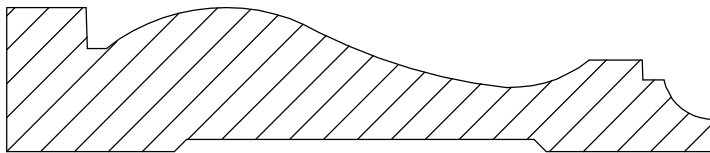

Casing 9-5
3/4" x 3 11/16"

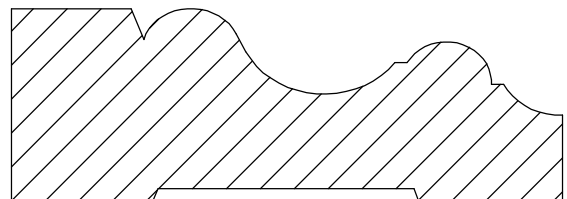

Casing 9-6
1" x 2 7/8"

Section 3: Casing, Backband & Plinth Mouldings

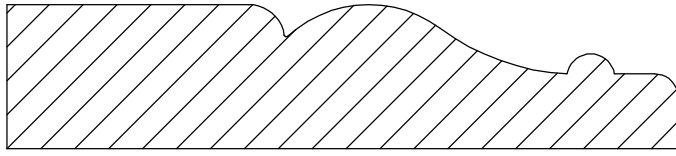

Casing 10-1
3/4" x 3 1/2"

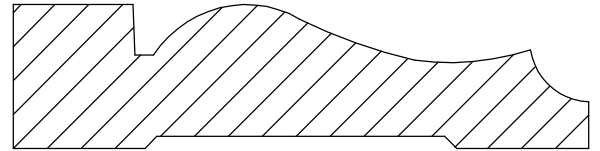

Casing 10-2
3/4" x 3"

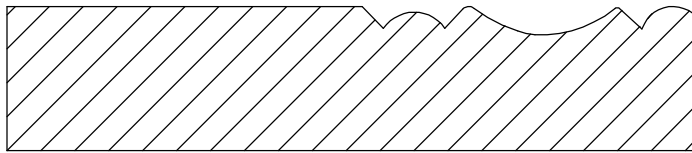

Casing 10-3
3/4" x 3 5/8"

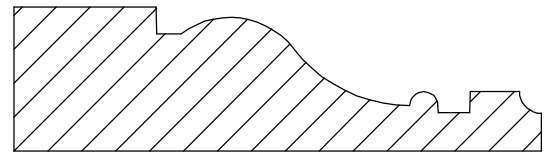

Casing 10-4
3/4" x 2 3/4"

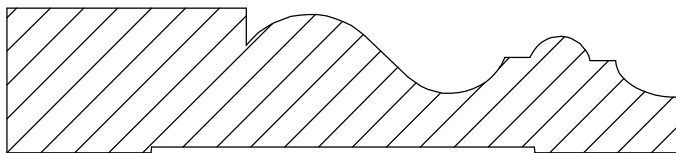

Casing 10-5
3/4" x 3 1/2"

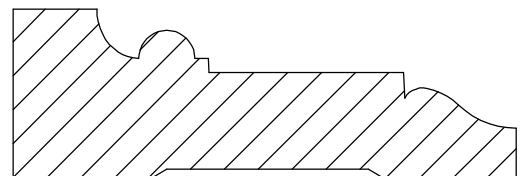

Casing 10-6
7/8" x 2 5/8"

Section 3: Casing, Backband & Plinth Mouldings

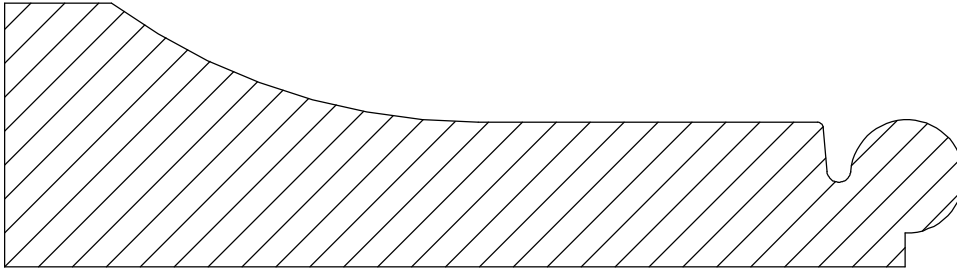

Casing 11-1
1 3/8" x 5"

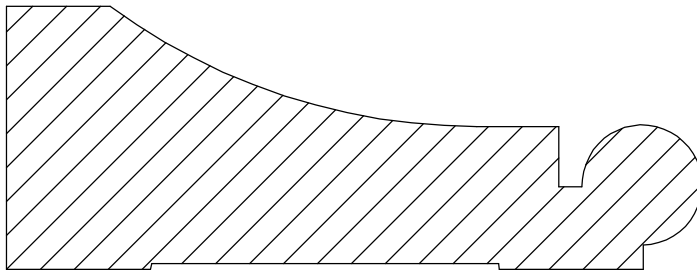

Casing 11-2
1 3/8" x 3 5/8"

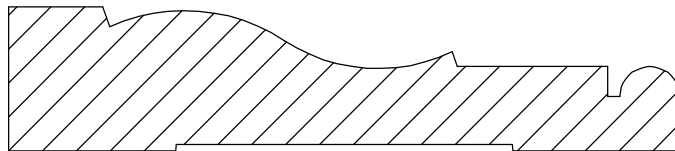

Casing 11-3
3/4" x 3 1/2"

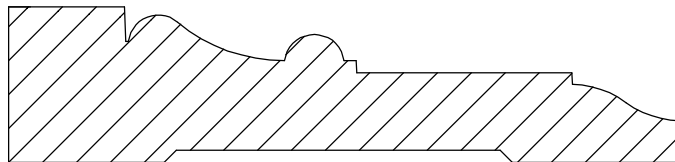

Casing 11-5
13/16" x 3 1/2"

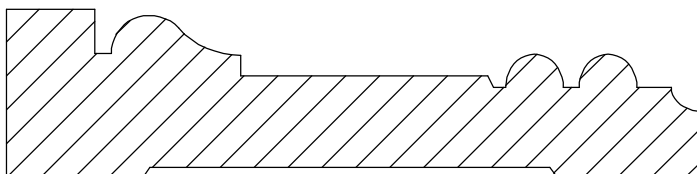

Casing 11-7
7/8" x 3 5/8"

Section 3: Casing, Backband & Plinth Mouldings

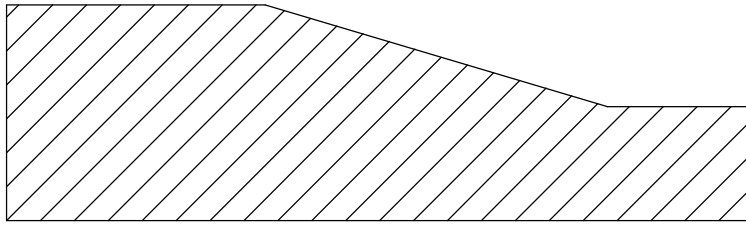

Plinth 12-1
1 1/8" x 3 7/8"

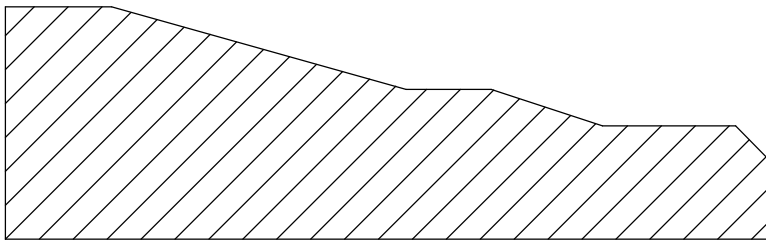

Plinth 12-2
1 1/4" x 4"

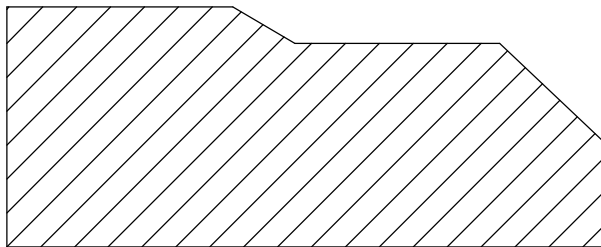

Plinth 12-3
1 1/4" x 3 1/8"

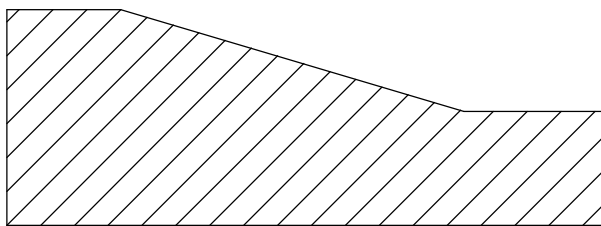

Plinth 12-5
1 1/8" x 3 1/8"

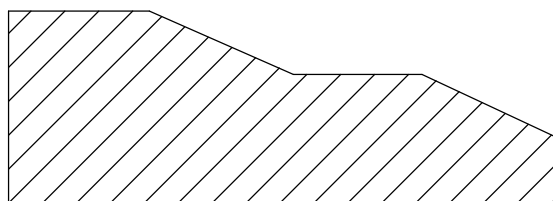

Plinth 12-5
1" x 2 7/8"

Section 3: Casing, Backband & Plinth Mouldings

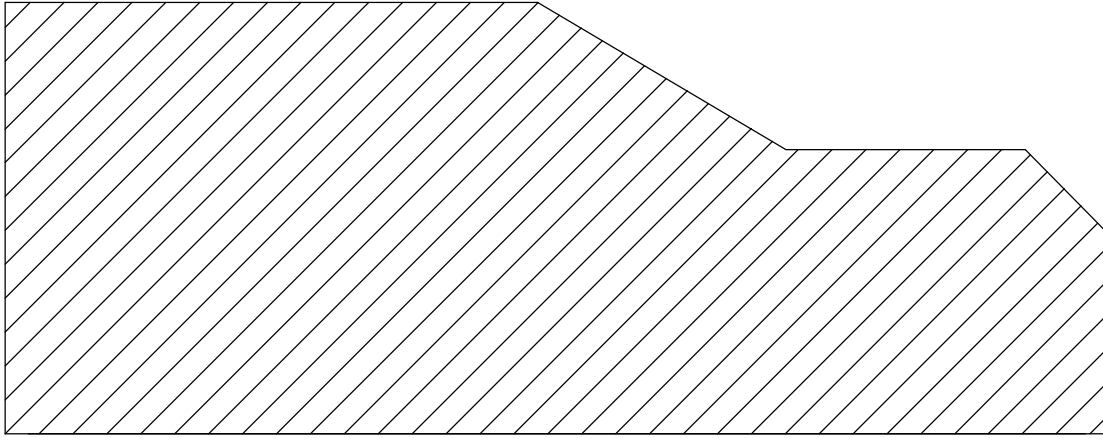

Plinth 13-1
2 1/4" x 5 3/4"

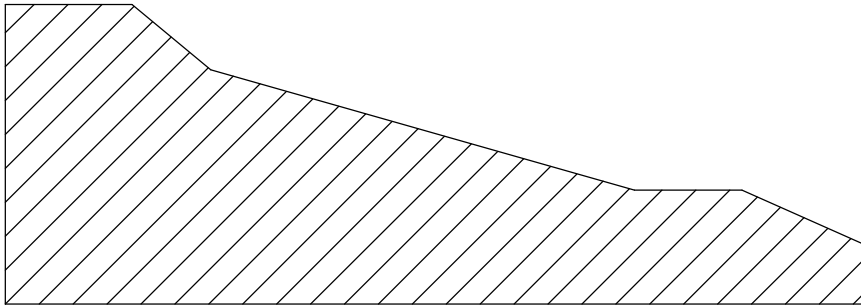

Plinth 13-4
1 9/16" x 4 1/2"

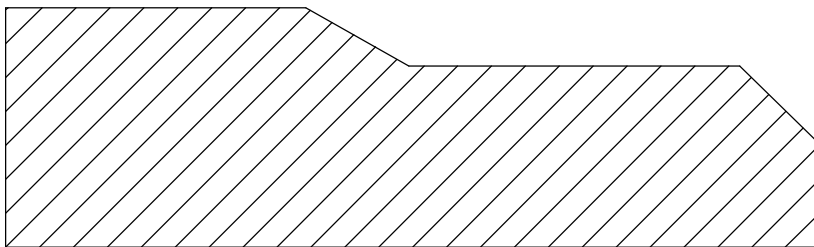

Plinth 13-3
1 1/4" x 4 1/4"

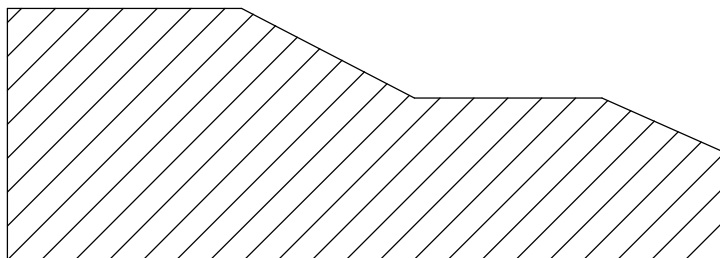

Plinth 13-2
1 5/16" x 3 3/4"

Section 3: Casing, Backband & Plinth Mouldings

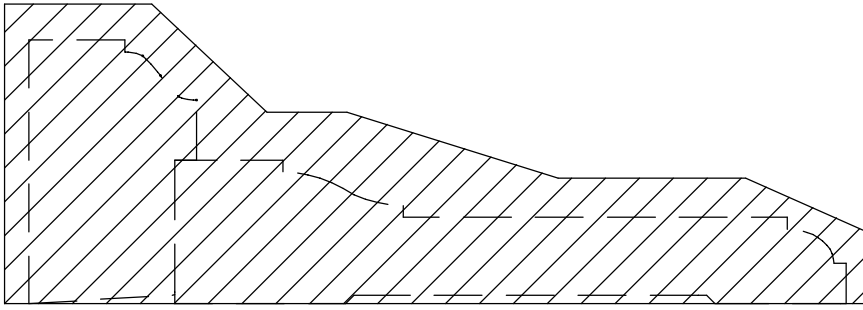

Plinth 14-1
1 9/16" x 4 1/2"

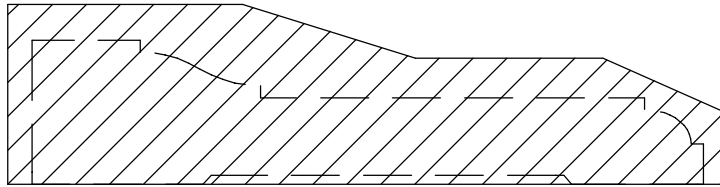

Plinth 14-2
15/16" x 3 3/4"

Section 3: Casing, Backband & Plinth Mouldings

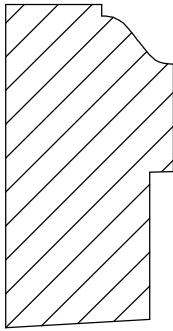

Backband 15-1
7/8" x 1 11/16"

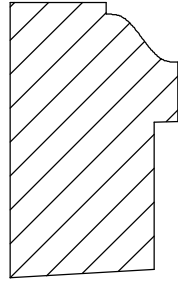

Backband 15-2
7/8" x 1 7/16"

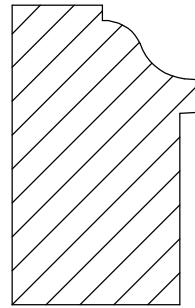

Backband 15-3
1" x 1 9/16"

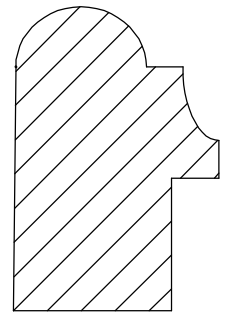

Backband 15-4
1 1/16" x 1 5/8"

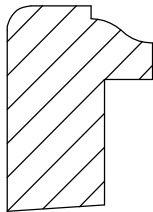

Backband 15-5
3/4" x 1 1/16"